

03/23-687

# Canon

# ELPH LT

**E**

**F**

**S**

**P**

## IXUS M-1



**E** English

**S** Español

**F** Français

**P** Português



## Handling Precautions

1. This camera is not resistant to water, and should not be used outdoors if it is raining or snowing. If it is accidentally dropped in water, contact an authorized Canon service facility. Keep the camera out of salt spray and excessive humidity. If used at the beach, clean it thoroughly afterward with a dry cloth.
2. Store the camera in a cool, dry, dust-free place. Be sure to keep the camera out of direct sunlight, and away from "hot spots" such as the trunk or rear window shelf of a car. Avoid places where mothballs are used, and use a desiccant in excessive humidity.
3. Do not attempt to disassemble the camera yourself, since there is high-voltage circuitry inside.
4. The battery may explode or cause burns if disassembled, recharged, shorted, exposed to high temperatures, or disposed of in a fire.
5. Use a blower brush to remove dust and sand from the lens and inside the camera. Do not apply any fluids to the lens or body. Take the camera to an authorized Canon service facility for a more thorough cleaning if necessary.
6. Film passing through X-ray examinations at an airport may be exposed and ruined even when loaded in the camera. Request a different method of inspection to avoid damage.
7. Color reproduction may be adversely affected if the film is left in the camera for a long time. Always develop exposed film promptly.

This device complies with Part 15 of the FCC Rules. Operation is subject to the following two conditions: (1) This device may not cause harmful interference, and (2) this device must accept any interference received, including interference that may cause undesired operation.

Do not make any changes or modifications to the equipment unless otherwise specified in the instructions. If such changes or modifications should be made, you could be required to stop operation of the equipment.

This equipment has been tested and found to comply with the limits for a class B digital device, pursuant to part 15 of the FCC Rules. These limits are designed to provide reasonable protection against harmful interference in a residential installation. This equipment generates, uses and can radiate radio frequency energy and, if not installed and used in accordance with the instructions, may cause harmful interference to radio communications.

However, there is no guarantee that interference will not occur in a particular installation. If this equipment does cause harmful interference to radio or television reception, which can be determined by turning the equipment off and on, the user is encouraged to try to correct the interference by one or more of the following measures:

- Reorient or relocate the receiving antenna.
- Increase the separation between the equipment and receiver.
- Consult the dealer or an experienced radio/TV technician for help.

---

This digital apparatus does not exceed the Class B limits for radio noise emissions from digital apparatus as set out in the interference-causing equipment standard entitled "Digital Apparatus", ICES-003 of the Industry Canada.

---

Cet appareil numérique respecte les limites de bruits radioélectriques applicables aux appareils numériques de Classe B prescrites dans la norme sur le matériel brouilleur: "Appareils Numériques", NMB-003 édictée par l'Industrie Canada.



The **CE** Mark is a Directive conformity mark of the European Community (EC)

**Thank you for purchasing this Canon product.**

Before taking pictures, please read these instructions carefully for a thorough understanding of how the camera operates.

## Table of Contents

These instructions are divided into four sections: Introduction, Basic Operations, Advanced Operations, and Additional Information. When first using the camera, be sure to read the instructions from the Introduction.

### Convention

The following convention is used in these instructions:



Warnings you should observe when using the camera.



Additional information on using the camera.

## 1

### Introduction

Handling Precautions .....	2
Table of Contents .....	4
ADVANCED PHOTO SYSTEM Features .....	6
Advanced Photo System Quick Reference....	8
Camera Quick Reference .....	10
Nomenclature .....	12
Attaching the Strap .....	14

## 2

### Basic Operations

1 Inserting the Battery .....	15
2 Loading the Film Cartridge .....	16
Checking the Film Information .....	17
3 Turning the Power On.....	18
Checking the Battery Power.....	19
4 Holding the Camera .....	20
5 Viewfinder .....	21

6	Shooting Range .....	22
	Shooting Through a Window .....	22
7	Selecting the Print Type (C/H/P).....	23
8	Shutter Button Action .....	24
	Green/Orange Indicators .....	25
9	Removing the Film Cartridge .....	26
	Film Cartridge Processing .....	27
	Handling Film Cartridges After Exposure .....	27

**E**

### 3 Advanced Operations

👁️⚡	Changing the Flash Mode .....	28
1	Auto Flash Mode without Red-eye Reduction .....	29
2	👁️ Auto Flash Mode with Red-eye Reduction .....	30
	Red-eye Reduction Function .....	32
3	⚡ Flash ON Mode.....	33
4	🚫 Flash OFF Mode .....	34
5	👁️⚡ Slow-synchro Mode with Red-eye Reduction .....	35
	Focus Lock .....	36
🕒	Self-timer Shooting .....	37
	Date and Time Imprinting .....	38
	Changing the Date Format .....	39
	Setting and Adjusting the Date/Time.....	40
	Imprinting Titles .....	42
	Selecting the Title Language.....	42
	Selecting the Title .....	43

1

2

3

### 4 Additional Information

	Troubleshooting .....	44
	Questions and Answers .....	45
	Specifications .....	46

4



## ADVANCED PHOTO SYSTEM

This camera supports the new Advanced Photo System. This system, as well as Canon's advanced technology has made it possible to produce a camera that is smaller than any previous camera. Here are some of the special features of this system.

### 1 New Film

The new IX240 film comes in a compact film cartridge with no leader. This new drop-in film can be easily loaded by anyone, and replaces all previous hard-to-load films. In addition, the visual exposure indicator on the top of the cartridge shows whether the film cartridge is unexposed, partial, exposed, or processed.

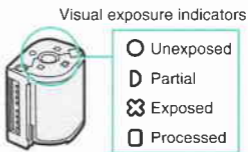

### 2 New Camera Size

The Advanced Photo System allows cameras and film cartridges to be much more compact than previously possible (Canon model comparison).

Moreover, Canon's advanced technology has made it possible to produce this ultra compact camera.

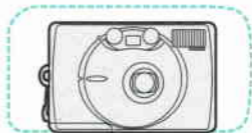

## Features

**E**

### 3 New Type Prints

The Advanced Photo System allows the camera to shoot three types of prints: in addition to classic print types (C print), you can now shoot wide-angle (H print) and panorama (P print) prints.

The Advanced Photo System can also imprint date/time information on the back of the print, or on the front and back of the print. The system can also imprint title text on the back of the print.

\*Character size, shape, color, position, and ability to print on both sides may vary according to the individual photo shop.

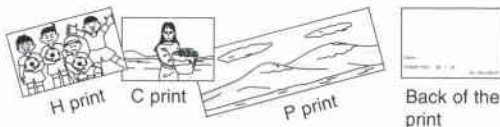

### 4 New Processing Methods

Previous 135 (35mm) film has always been returned from the processing lab as negative strips. This has made ordering reprints inconvenient since each picture must be found on the negative strips. With the Advanced Photo System however, the negative film is returned from the certified shop reloaded in its cartridge, accompanied by an index print. Unlike hard-to-see negative strips of previous cameras, this index print (where all shots can be viewed) makes reviewing prints much easier. Users can now order reprints simply by matching the ID on the back of the print or on the index print with the ID on the film cartridge, and then specifying the print number to be reprinted at the photo shop.

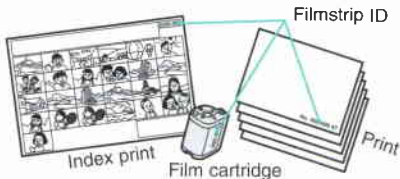
**1**

## Advanced Photo System Quick Reference

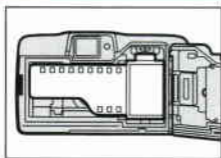

Previous film

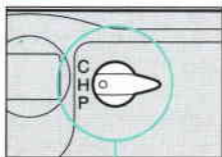
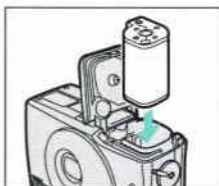

Print type selection lever



C print



H print



P print

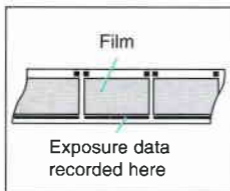

Data recorded on film  
(example)

- Date and title
- Print type
- Film orientation
- Flash ON/OFF
- Subject brightness
- Etc.

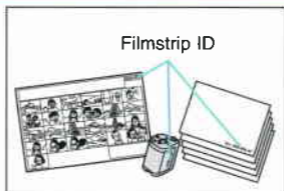



For further details, refer to the page indicated.

## **1 Simple film cartridge loading. (→ 16)**

- Unlike previous 135 (35mm) film, there is no need to open the back cover and pull the film leader across the back of the camera.

**E**

## **2 Choose the print type with the print type selection lever. (→ 23)**

- ➔ You can choose from three print types.
- C print: Classic print
  - H print: Wide-angle print
  - P print: Panorama print

## **3 A variety of data (IX information) is recorded magnetically on the film surface.**

- All the information described at left can be recorded on the film.
- The exposure information is used in the printing process to produce better quality prints.

**1**

## **4 Exposed film cartridges can be processed for printing at Advanced Photo System certified shops. (→ 27)**

- ➔ After developing the film, the shop will return your pictures, along with an index print, and the film cartridge with the film inside.
- When ordering reprints from a certified shop, just match the ID on the back of the print or on the index print sheet with the ID on the film cartridge, and specify which prints you want.

## Camera Quick Reference

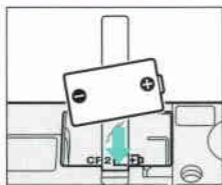

- 1** Open the battery cover and insert the battery.  
(→ 15)

- Close the battery cover after inserting the battery.

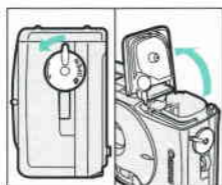

- 2** Open the film cartridge compartment cover.  
(→ 16)

- To open, rotate the knob to the left.

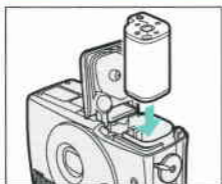

- 3** Insert the film cartridge and close the film cartridge compartment cover.  
(→ 16)

- Check that the visual exposure indicator is ○ (unexposed).

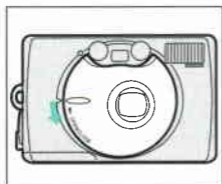

- 4** Slide the main switch downwards to the **OPEN/CLOSE** position to turn the camera on.  
(→ 18)

- ➔ The lens cover is opened.
- ➔ The switch automatically returns to its original position.

For further details, refer to the page indicated.

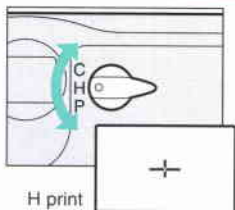

**5** Select the print type with the print type selection lever. (→ 23)

➔ The viewfinder field changes.

**E**

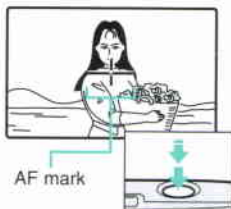

**6** Place the AF mark over the subject and press the shutter button. (→ 24)

➔ The flash fires automatically in low light conditions.

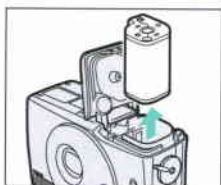

**7** When the film cartridge has finished and the film has rewound, remove the cartridge from the camera. (→ 26)

- Check that the  indicator on the LCD panel is blinking then open the film cartridge compartment cover.
- Remove the film and close the film cartridge compartment cover.

**1**

## Nomenclature

\* (→ ■) is shorthand for “See page ■”.

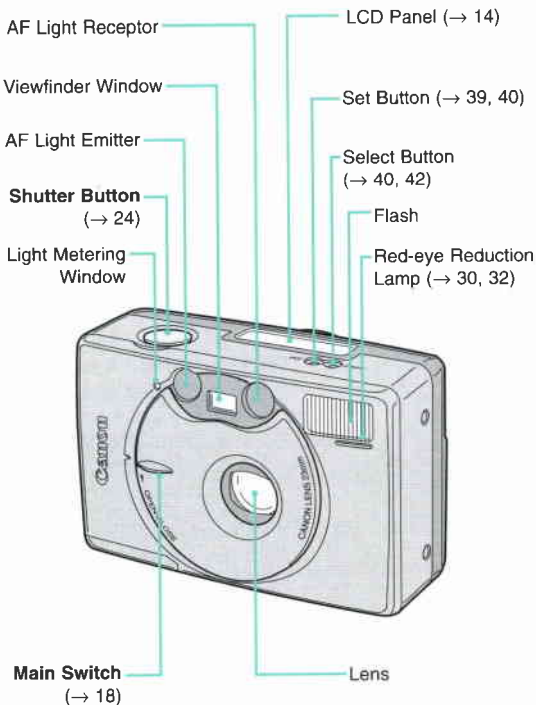

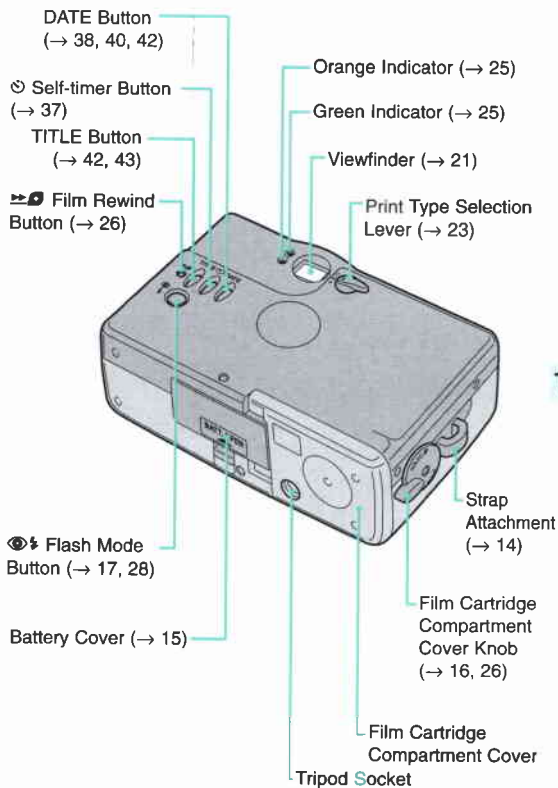

## Nomenclature/Attaching the Strap

### LCD Panel

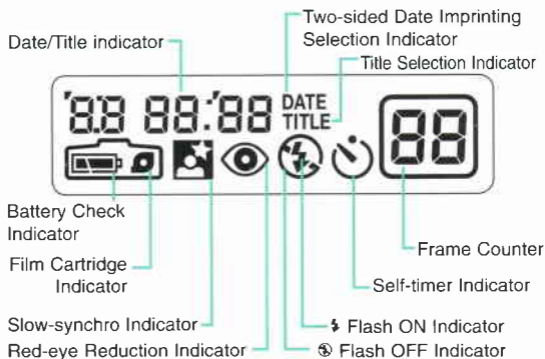

Normally the necessary indicators will be displayed on the LCD panel.

### Attaching the Strap

Before using your camera, attach the strap provided. Be careful not to drop the camera.

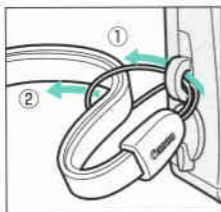

**Pass the strap through the strap attachment on the side of the camera.**

• Follow step ① before step ②.

- Use the push-button projection on the strap clasp to press the Select (→ 40), Set (→ 39), and the film rewind buttons (→ 26).

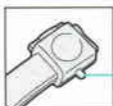

Push-button projection

## 1 Inserting the Battery

Battery: One lithium battery (CR2)

E

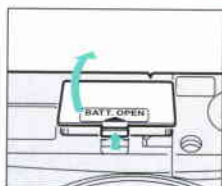

### 1 Open the battery cover.

- While pressing the ridges on the battery cover, lift off the cover.

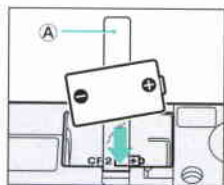

### 2 Insert the battery.

- Insert the battery with the + and - terminal positioned correctly with the release tape **A** is behind the battery.
- ➔ The  indicator is displayed on the LCD panel.

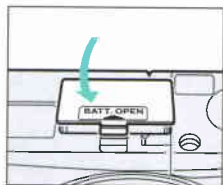

### 3 Close the battery cover.

- Be careful not to trap the release tape when closing the battery cover.
- ➔ If "-- --" blinks in the LCD panel, after you change the battery, you will need to reset the date to the correct date and time (→ 40).

1

2

## Removing the Battery

- Slowly pull the end of the release tape to remove the battery.



- After removing the battery to replace it, do not touch any of the switches on the camera. This will allow the date and time settings to be retained for approximately five seconds.

## 2 Loading the Film Cartridge

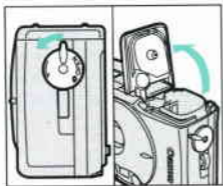

### 1 Open the film cartridge compartment cover.

- Rotate the film cartridge compartment cover knob to the left.

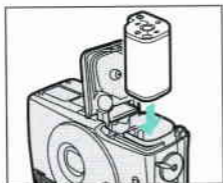

### 2 Load a film cartridge.

- Load the film cartridge with the visual exposure indicator end facing outwards.
- Always use unexposed film (→ 17).

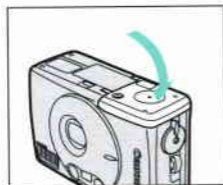

### 3 Close the film cartridge compartment cover.

- Close until it clicks.
- ➔ The  indicator on the LCD panel lights up.

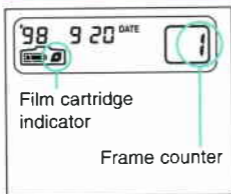

### 4 The film automatically advances to the first frame and "1" is displayed in the frame counter.

- If "1" is not displayed, check if the film cartridge is loaded correctly.



### Film cartridges

- Use IX240 film cartridge.
- Previous 135 (35mm) print film cannot be used.
- Use film cartridges whose visual exposure indicator is ○ (unexposed).



### Checking the Film Information

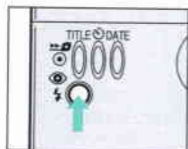

Turn off the camera and press the flash mode button (⊕/⊖).

➔ The information is displayed in the LCD panel as shown in the illustration below.

The film types displayed are:

⊂ : Color negative film

⊂ : Color reversal (slide) film

bL : Black and White (monochrome) film

-- : Other type of film

Total number of frames

Film type



Film speed



- Film cartridges with the ⊕ (partial) indicator cannot be used in this camera.
- If a cartridge with the ⊕ (partial) indicator is loaded, it will be set to ⊗ (exposed) and you will not be able to take any more pictures with that cartridge.
- If ⊕ (partial), ⊗ (exposed) or ⊖ (processed) film cartridges are loaded, the "0" in the frame counter and the ⊕ indicator will blink. Reload with a ○ (unexposed) film cartridge.

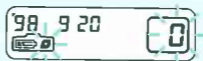

### 3 Turning the Power On

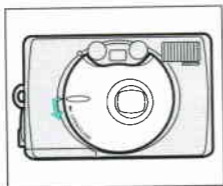

**Slide the main switch downwards to the OPEN/CLOSE position.**

- ➔ The lens cover is opened.
- ➔ The switch automatically returns to its original position.
- ➔ The flash mode is set to auto flash (full auto operation) mode.

### Turning the power off

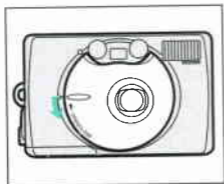

**Slide the main switch downwards to the OPEN/CLOSE position.**

- ➔ The lens cover is closed.
- ➔ The switch automatically returns to its original position.



## Checking the Battery Power

Check that  is displayed on the LCD panel when the power is turned on.

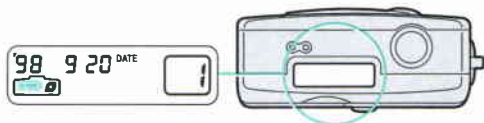
Shooting capacity with a new battery – Approx. 22 film cartridges of 25 exposures, at normal temperatures with 50% flash use. (Data based on Canon's Standard Test Method.)



### Battery Check Indicator

-  (Lit): Battery is full
-  (Lit): Have a new battery ready
-  (Blinks): Replace the battery (→ 15)



- Use one lithium battery (CR2).
- Before shooting, be sure to check the battery power.
- The shooting capacity is reduced to about 1/3 of normal if the camera is used at low temperatures.
- When traveling or planning to take many pictures, be sure to take a supply of spare batteries, they may not be available where you are.
- Shooting continuously with the flash will cause the battery power to fall momentarily, and the LCD panel display may be incorrect. Turn the power off and wait a while before turning it back on.

## 4 Holding the Camera

To take sharp pictures, and prevent camera shake, hold the camera as shown in the illustrations below.

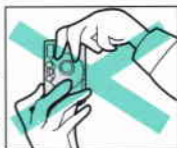
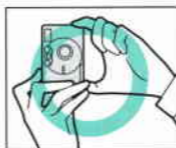

- To avoid including your fingers in the shot and camera shake, always hold the camera with both hands.
- Keep your elbows close to your body.
- Hold the camera against your nose and look through the viewfinder.



- Be careful to keep hair and fingers from blocking the lens, AF light emitter/receptor, light metering window, and flash.

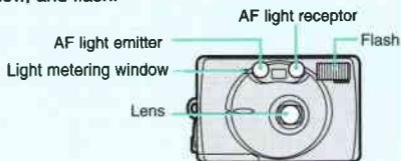

## 5 Viewfinder

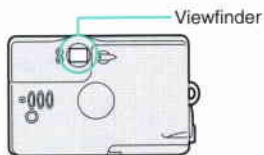

E

### Viewfinder Frames

#### Picture Frame

Compose your picture within this frame. (H print)

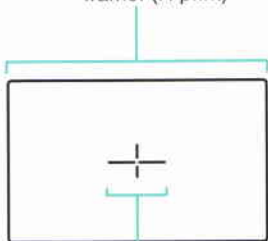

#### AF Mark

Place this mark over the subject you wish to take.

2

## 6 Shooting Range

The shooting range of the camera varies according to the flash mode selected.

- In Flash OFF mode ( $\rightarrow$  34) the shooting range is 1 m (3.3 ft.) to infinity.
- In all other modes ( $\rightarrow$  28) the shooting range is 0.6 m (2 ft.) to infinity. However, the flash will fire if the range is between 0.6 and 1 m (2 and 3.3 ft.). This means you will not be able to take the picture until the flash has charged (max. three sec.). Be sure to press the shutter button halfway and take the picture after the green and orange lamps are lit.

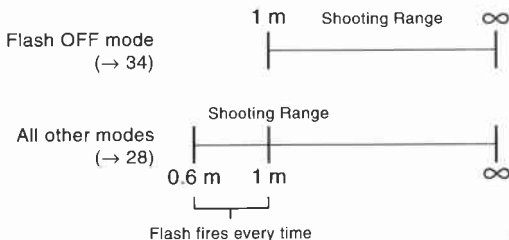

### Shooting Through a Window

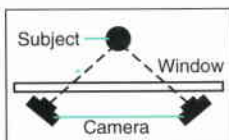

If you are taking a picture through a window, set the camera at an appropriate angle, with camera as close to the window as possible (within 20 cm/7.9

ins.). If you are too far away from the window, the camera may focus on the glass of the window rather than the subject.

## 7 Selecting the Print Type

You can choose from three print types with this camera: C print, H print or P print.

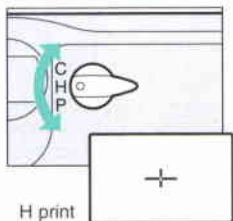
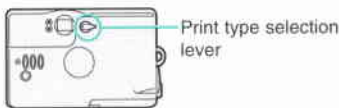

**Use the print type selection lever to select the desired print type.**

- You can change the print type in mid roll.

The viewfinder field changes when the print type selection lever is used. The black areas in the viewfinder will not be printed.

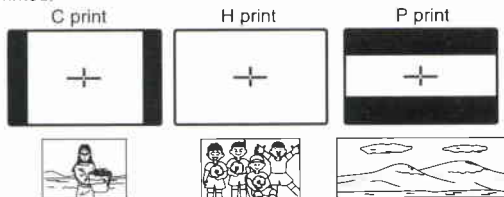

Choose a print type suitable for the subject you are shooting.



- For accurate framing for P prints, you should be 2 m (6.6 ft.) or further from the subject.

## 8 Shutter Button Action

This camera has a two-step shutter button. When the shutter button is pressed halfway, the exposure and focus are set. When the button is pressed fully, the shutter is released.

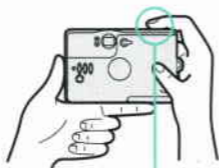

AF mark



### 1 Place the AF mark over the subject and press the shutter button halfway.

- ➔ The subject is focused.
- Check that the green indicator is lit.
- Keep the shutter button pressed halfway.

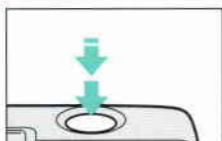

### 2 Press the shutter button fully.

- Press the shutter button gently.
- ➔ The shutter is released.



- There is a very short interval between the shutter button being pressed and the shutter being released. As a general guide, it is best to hold the camera still until you hear the film start to wind forward.



## Green/Orange Indicators

When the shutter button is pressed halfway, the indicators light up or blink to indicate whether or not shooting is possible.

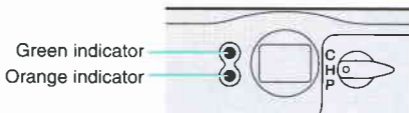

### Green indicator

Lights up: Ready for shooting (Subject in focus)  
 Blinks (4 times/sec.): Close-range warning (See ① below)

### Orange indicator

Lights up: Flash has charged  
 Blinks (4 times/sec.): Camera shake warning in "Flash OFF" mode (See ② below)





- ① If the close-range warning appears, release the shutter button and move away from the subject slightly, then press the shutter button halfway again. The close-range warning range is as shown in the table below. However, the indicator may light up when the subject is closer than 30 cm (1 ft.). Make sure that you are not too close to the subject.

Film Type	Flash Mode	Close Range Warning Range
C/H	Other than Flash OFF	30 to 60 cm (1 to 2 ft.)
	Flash OFF	30 cm to 1 m (1 to 3.3 ft.)
P	All modes	30 cm to 2 m (1 to 6.6 ft.)



- ② We recommend you mount the camera on a tripod if the camera shake warning appears.

## 9 Removing the Film Cartridge

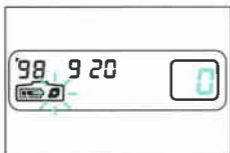
The film rewinds automatically when it reaches the end. The frame counter counts down during film rewinding. When the film has been fully rewound, the  indicator on the LCD panel blinks. Check that the  indicator on the LCD panel is blinking before removing the cartridge from the camera.



### 1 Check that is blinking.

- Press the film rewind button () if  is not blinking.

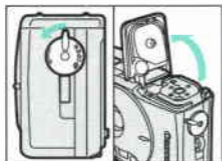

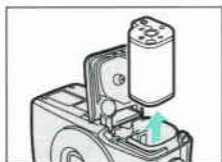

### 2 Open the film cartridge compartment cover.

- Rotate the film cartridge compartment cover knob to the left.





### 3 Remove the film cartridge.

- ➔ The  indicator on the LCD panel disappears.
- ➔ The visual exposure indicator on the film cartridge becomes  (exposed).

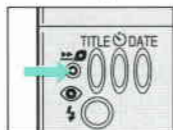
## Rewinding a film cartridge in mid-roll



- Press the film rewind button ()
- The visual exposure indicator on the film cartridge changes to  (exposed).

## Film Cartridge Processing

- Exposed film cartridges can be processed for printing at Advanced Photo System certified shops.
- All certified shops do the following:
  - ① Return your cartridge with the film inside.
  - ② Process all three types of prints.
  - ③ Make an index print sheet.
  - ④ Use the print quality data for better quality prints.
  - ⑤ Imprint the date and title on the back of the print.

## Handling Film Cartridges After Exposure

- When ordering reprints at a certified shop, be sure to match the ID number from the back of the print you want or from the index print with the ID on the film cartridge before handing in your film cartridge.

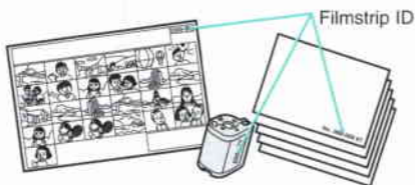

- Handle and store index prints and returned film cartridges carefully.
- The visual exposure indicator is set to ☒ (exposed) for film cartridges that have been fully exposed, and to ☐ (processed) for film cartridges that have been developed.
- Do not place cameras or film cartridges near televisions, speakers, or other sources of strong magnetic fields.

## Changing the Flash Mode

The flash can be made to fire every time you take a picture, or it can be turned off. Choose a mode suitable for the subject and place you are shooting. Select the flash mode while the camera is turned on.

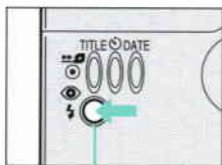

Flash mode button

### Press the flash mode button (⚡).

- You can check the mode on the LCD panel.



- \*: (⚡) Auto flash without red-eye reduction (→ 29)
- \*: ⚡(⚡) Auto flash with red-eye reduction (→ 30)
- ⚡ Flash ON (→ 33)
- ⊕ Flash OFF (→ 34)
- ⚡(⚡) Slow-synchro with red-eye reduction (→ 35)

\*: When the flash is set to fire automatically, (⚡) appears on the LCD panel when the shutter button is pressed halfway.



- The default setting when the camera is turned on is (⚡). To change to ⚡(⚡) after the power is turned on, turn the power off when ⚡(⚡) is displayed. When the power is turned on again, ⚡(⚡) will be displayed. To revert to the original state, turn the power off when (⚡) is selected.

## 1 Auto Flash Mode without Red-eye Reduction

Set this mode for taking pictures without people, or if you want to shoot right away without the red-eye reduction function.

In low light conditions, the flash fires automatically when the shutter button is pressed.

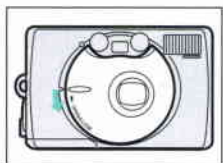



Slide the main switch downwards to the **OPEN/CLOSE** position to turn the power on.



### Flash Distance Range (With color print film)

Film Speed	Flash Range
ISO 100	0.6 to 2.3 m (2 to 7.6 ft.)
ISO 200	0.6 to 3.2 m (2 to 10.5 ft.)
ISO 400	0.6 to 4.6 m (2 to 15 ft.)





- If  is displayed on the LCD panel, press the flash mode button () until all the flash mode indicators disappear.

## Changing the Flash Mode

### 2 Auto Flash Mode with Red-eye Reduction

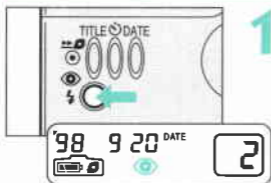
Set this mode when shooting pictures of people in low light conditions to reduce red-eye effect (→ 32). When the shutter button is pressed, the red-eye reduction lamp lights up and the flash fires.



**1** Press the flash mode button () until  is displayed on the LCD panel.

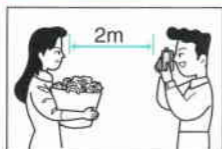

**2** Stay within about 2 m/ 6.6 ft of your subject.

- The red-eye reduction lamp is only effective within this distance.



**3** Tell your subject to look at the camera.

- The red-eye reduction function is not effective unless the subject looks straight at the lamp.

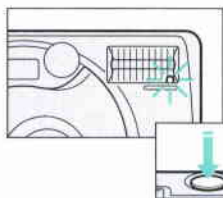

## 4 Press the shutter button halfway.

- ➔ The red-eye reduction lamp lights up and the shutter will not release for about one second.
- Keep the shutter button pressed halfway.

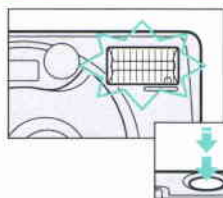

## 5 After about one second, press the shutter button fully.

- ➔ The flash fires and the shutter is released.



- When the red-eye reduction lamp lights up, the shutter will not release for about one second. This is to increase the effectiveness of the red-eye reduction function. If you want to shoot right away, turn the red-eye reduction function off with the flash mode button (👁️/🔴).



### Important guidelines for using the red-eye reduction function

1. This function is not effective unless the subject looks directly at the red-eye reduction lamp while it is lit. Be sure to tell your subject to look straight at the lamp.
2. Stay within 2 m (6.6 ft.) of your subject.
3. The efficacy of the red-eye reduction function varies from person to person.
4. Try to raise the ambient light level as much as possible.

## Changing the Flash Mode

### **Red-eye Reduction Function**

With flash photography in dark places, the subject's eyes may appear red. This phenomenon is called "red-eye" and occurs when flash illumination reflects off the retina.



With the red-eye reduction function (  indicator), the red-eye reduction lamp lights up to illuminate the subject for about one second before the flash is fired. This will minimize the chances of red-eye.

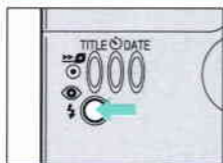
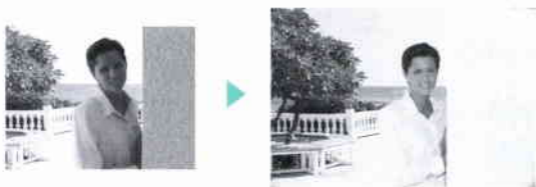

### 3 Flash ON Mode

The flash fires regardless of the light conditions. Set this mode for fill-in flash during the day, or to soften the outline of the subject.



Press the flash mode button () until  is displayed on the LCD panel.





## Changing the Flash Mode

### 4 Flash OFF Mode

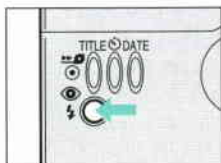
The flash will not fire even in low light conditions. Use this mode where flash photography is prohibited, for night views, or for available-light photography.



Press the flash mode button () until  is displayed on the LCD panel.





- A slow shutter speed (max. approx. 1/2 sec.) is set in low light conditions; be careful not to move the camera.
- If the orange indicator blinks to indicate camera shake, place the camera on a steady surface or mount it on a tripod.

## 5 Slow-synchro Mode with Red-eye Reduction

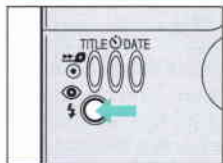
This mode is effective when taking pictures of people with an evening or nocturnal background. Flash and slow shutter speed are effectively combined, so that the flash illuminates the subject, and the slow shutter speed captures the distant background.



Press the flash mode button () until ,  and  are displayed on the LCD panel.



3



- A slower shutter speed (max. approx. 1/2 sec.) is set in this mode; be sure to use a tripod to avoid camera shake. Also, tell your subject to keep still for a moment after the flash has fired.



- The red-eye reduction function operates in this mode.
- In certain shooting situations, "Auto flash" mode may be more effective for shooting. We therefore recommend you take pictures in both "Slow-synchro" and "Auto flash" modes.

## Focus Lock

Use this mode to focus on a subject positioned close to the edge of the picture frame.

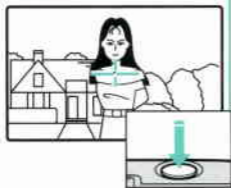
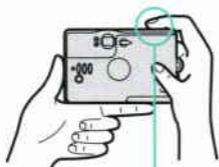

- 1 Center the AF mark over the subject and press the shutter button halfway.**

➔ The subject is focused when the green indicator lights up.

- Keep the shutter button pressed halfway.

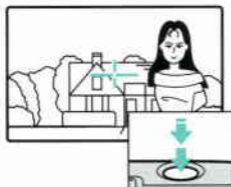

- 2 With the shutter button pressed halfway, frame your picture as desired. Then press the shutter button fully.**

➔ The shutter is released.



• Be careful not to change the distance between the subject and the camera. If you do change it, redo focus lock.

## ☺ Self-timer Shooting

Include yourself in the picture by delaying shutter release with the self-timer. Place the camera on a steady surface, or mount it on a tripod. Select the self-timer mode while the camera is turned on.

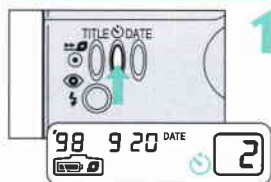

### 1 Press the self-timer button (☺).

→ The ☺ indicator is displayed on the LCD panel.

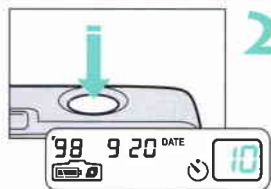

### 2 Compose the picture, then press the shutter button.

→ The red-eye reduction lamp blinks (once/sec.) for about 10 seconds before the shutter is released.

→ The LCD panel counts down the remaining seconds.

### Canceling the self-timer

- Press the self-timer button (☺) again.



- Do not stand in front of the camera when pressing the shutter button; this will cause incorrect focus.



- The lamp blinks more rapidly approximately two seconds before the shutter is released. However, if the red-eye reduction function has been activated, the lamp will remain lit during the last two seconds before the shutter is released.

## Date and Time Imprinting

The date and time that a photo is taken can be imprinted on the back or the front and back of the print.

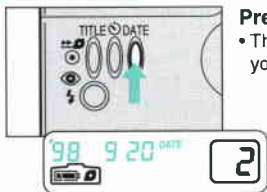

**Press the DATE button.**

- The mode changes every time you press the button.

### LCD Panel Date Display

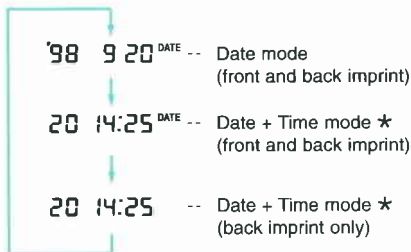

★: The date and time format for the date display (e.g. 20 14:25) is printed using the format selected in Date mode.



- **Character size, shape, color, position, and ability to print on both sides may vary according to the individual photo shop.**
- Date, time, and title are not photographically imprinted on the film, but are imprinted as part of the developing process, using data (IX information) magnetically recorded on the film.
- In addition to date/time imprinting, the back of the print provides space to imprint the ID of the film cartridge and the frame number.

## Changing the Date Format

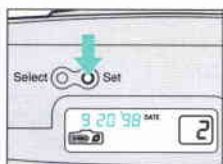

**In Date mode, press the Set button to select the date format.**

- Use the push-button projection on the strap clasp.
- ➔ The date format changes in the following order:
  - year/month/day
  - month/day/year
  - day/month/year.



## Setting and Adjusting the Date/Time

After changing the battery, or when traveling internationally, it may be necessary to set or adjust the camera's date and time using the following procedure.

**If "-- -- --" blinks on the LCD panel when you change the battery, perform steps 2, 3, 4, and 6.**

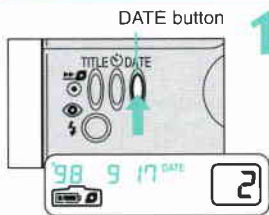

### 1 Press the DATE button to display the Date mode.

- The time is set in Date + Time mode, step 5.

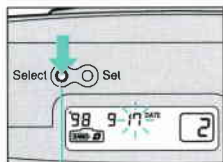

Select button

### 2 Press the Select button.

- Use the push-button projection on the strap clasp.
- ➔ When you replace the battery, the blinking "-- -- --" display changes to "98 1 1".
- The digits to be set start blinking.

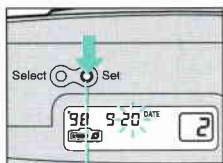

Set button

### 3 Press the Set button.

- Use the push-button projection on the strap clasp.
- Press repeatedly until the blinking digits show the desired value.



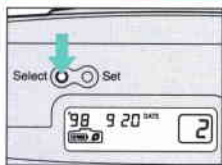

**4** Repeat steps 2 and 3 until all digit settings and adjustments are completed, then press the Select button to end.

- The date adjustment is complete when the digits stop blinking.



**5** Press the DATE button to display the Date + Time mode.

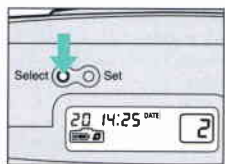

**6** Repeat steps 2 and 3 until all digit settings and adjustments are completed, then press the Select button to end.

- The time adjustment is complete when the ":" in the time display stops blinking.



- If "-- --" blinks on the LCD panel (no Date imprinting) when the battery is replaced, reset the date and time.



- Press the Set button to advance the digit by one, or hold for two seconds or more to advance the value continuously.
- The date cannot be set or adjusted in Date + Time mode.
- After removing the battery to replace it, do not touch any of the switches on the camera. This allows the date and time settings to be retained for approximately five seconds.

## Imprinting Titles

You can imprint titles on the back of the print. Select a title from the different titles available while the camera is turned on.

### Selecting the Title Language

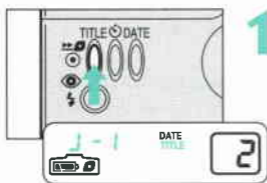

- 1 Press the TITLE button.**
  - ➔ The word TITLE is displayed on the LCD panel.

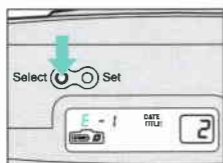

- 2 Press the Select button to select the language.**
  - The language changes every time you press in this order: Japanese, English, French, German, Spanish, Italian.

### Canceling Title Imprinting

- Press the DATE button until the word TITLE disappears from the LCD panel.



- The title imprinting function automatically returns to a date/time setting after one frame is exposed. To continuously imprint the same title, hold down the Title button for two seconds or longer (until the word TITLE blinks on the LCD panel).
- **Character size, shape, color, position, and ability to print on both sides may vary according to the individual photo shop.**
- The date and time as set by the Date function are also printed with the title.
- If you want information imprinted on the front of your prints, be sure to check with the photo shop, that they provide this service, before the film is processed.

## Selecting the Title

Once you have selected the language for your title, you can select the title.

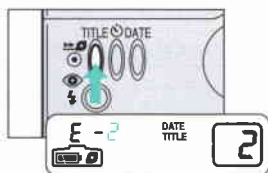

**Press the TITLE button.**

- ➔ The title number changes every time you press.
- Select the title you want to use, then take the picture.

### TITLE button Sequence

E-1 I LOVE YOU

E-2 THANK YOU

E-3 SEASON'S GREETING

E-5 HAPPY BIRTHDAY

E-4 CONGRATULATIONS

#### Japanese Titles

- J-1 オメデトウ
- J-2 カングキ!
- J-3 カワイイデショ!
- J-4 ヨロシク!
- J-5 ウレシイナ

#### French Titles

- F-1 JE T'AIME
- F-2 MERCI
- F-3 MEILLEURS VOEUX
- F-4 JOYEUX ANNIVERSAIRE
- F-5 FÉLICITATIONS

#### Italian Titles

- I-1 TI AMO
- I-2 GRAZIE
- I-3 BUONE FESTE
- I-4 BUON COMPLEANNO
- I-5 CONGRATULAZIONI

#### German Titles



- D-1 ICH LIEBE DICH
- D-2 DANKE SCHÖN
- D-3 HERZLICHE GLÜCKWÜNSCHE
- D-4 FRÖHLICHE WEIHNACHTEN
- D-5 FROHES NEUES JAHR

#### Spanish Titles

- ES-1 TE QUIERO
- ES-2 GRACIAS
- ES-3 FELICES PASCUAS
- ES-4 FELIZ CUMPLEAÑOS
- ES-5 FELICIDADES

## Troubleshooting

In case of trouble check the table below before taking your camera to be repaired.

Problem	Cause	Remedy	Page
The battery check indicator  blinks.	<ul style="list-style-type: none"> <li>•The battery has expired.</li> </ul>	<ul style="list-style-type: none"> <li>•Replace the battery.</li> </ul>	15
The battery check indicator  is not displayed.	<ul style="list-style-type: none"> <li>•No battery is loaded.</li> <li>•The battery is inserted with the wrong polarities.</li> </ul>	<ul style="list-style-type: none"> <li>•Load a battery.</li> <li>•Reinsert the battery correctly.</li> </ul>	15 15
	<ul style="list-style-type: none"> <li>•The battery has completely expired.</li> </ul>	<ul style="list-style-type: none"> <li>•Replace the battery.</li> </ul>	15
The shutter does not release.	<ul style="list-style-type: none"> <li>•The power is turned off.</li> </ul>	<ul style="list-style-type: none"> <li>•Turn the power on.</li> </ul>	18
	<ul style="list-style-type: none"> <li>•The battery has expired.</li> </ul>	<ul style="list-style-type: none"> <li>•Replace the battery.</li> </ul>	15
	<ul style="list-style-type: none"> <li>•A cartridge that cannot be used has been loaded in the camera.</li> </ul>	<ul style="list-style-type: none"> <li>•Remove the film cartridge and load a new one.</li> </ul>	16, 26
	<ul style="list-style-type: none"> <li>•The shutter will be released only after the red-eye reduction lamp is lit for about 1 second.</li> </ul>	<ul style="list-style-type: none"> <li>•Keep pressed until the shutter is released.</li> <li>•Change the flash mode.</li> </ul>	31 28
The photographs are blurred.	<ul style="list-style-type: none"> <li>•When the shutter was released, the AF light emitter/receptor were blocked.</li> </ul>	<ul style="list-style-type: none"> <li>•Ensure that the AF light emitter/receptor are not blocked by hair, fingers, etc.</li> </ul>	20
	<ul style="list-style-type: none"> <li>•In self-timer shooting, you stood immediately in front of the camera when pressing the shutter button.</li> </ul>	<ul style="list-style-type: none"> <li>•Make sure you do not stand immediately in front of the camera when pressing the shutter button.</li> </ul>	37
	<ul style="list-style-type: none"> <li>•The camera moved when the shutter button was pressed (camera shake).</li> </ul>	<ul style="list-style-type: none"> <li>•Press the shutter button gently.</li> </ul>	24

Problem	Cause	Remedy	Page
"H" is displayed on the LCD panel.	•The self-diagnosis function detected an error.	•Remove the battery from the camera. When "H" disappears from the LCD display, load the battery again.	15
The film cartridge compartment cover will not open, even when the film counter reads 0.	•A problem occurred after rewinding.	•Press the film rewind button (⏮).	26

## Questions and Answers

### Q1 Can format 135 (35mm) film be used?

A1 No it cannot be used. Use IX240 film cartridge.

### Q2 Can slide film be used with this camera?

A2 Yes it can, if the film speed is less than ISO 400.

### Q3 What is ISO?

A3 The ISO number indicates the film's sensitivity to light in numerical terms. The higher the number, the more sensitive the film is to light.

### Q4 The picture was taken with date imprinting, but it doesn't appear on the index print. Why is this?

A4 The date and time are recorded on the film surface magnetically. This data is read electronically and printed during the printing process. This is why the date and time data may not appear on the index print sheets.

### Q5 Compared to a 35mm camera, what is this camera's 23 mm focal length equivalent to?

A5 Approximately 29 mm (for H prints).

## Specifications

**Type:** IX240 lens/shutter type, AF, fully automatic camera with magnetic IX functions

**Image Size:** 16.7 × 30.2 mm

**Lens:** Canon 23 mm f/4.8

**Focus Control:** Active auto-focus system

**Shooting Distance:** 0.6 m (2.0 ft.) to infinity  
(Flash OFF mode: 1 m (3.3 ft.) to infinity)

**Shutter:** Combination aperture and program electromagnetic drive shutter

**Viewfinder:** Real-image viewfinder

**Picture coverage:** Approx 87%

**Viewfinder Displays:** Picture frame, AF mark

**Viewfinder Eyepiece Area:**

Green indicator: Ready for shooting or close range warning

Orange indicator: Flash charge completion indicator or camera shake warning

**Film Loading:** Automatic (automatic blank film advance)

**Film Winding:** Automatic

**Film Rewinding:** Automatic at end of film, mid-roll rewinding possible

**Frame Counter:** Counts up during winding, counts down during rewinding

**Self-timer:** Electronically-controlled 10-second delay timer, activated by pressing the shutter button. The red-eye reduction lamp blinks during operation and the frame counter counts down the remaining seconds.

**Metering Range (ISO 100):**

AUTO/Flash ON modes:

1/60 f/4.8 to 1/650 f/14 (approx. EV 10.4 to EV 17)

Flash OFF/Slow-synchro modes:

1/2 f/4.8 to 1/650 f/14 (approx. EV 5.5 to EV 17)

**Film Speed Setting:** ISO 25 to 10000; Automatically set in 1/3-step increments

**Built-in Flash:** Internal flash with automatic operation in low light conditions

**Flash Range:** ISO 100: 0.6 to 2.3 m (2 to 7.6 ft.)  
ISO 200: 0.6 to 3.2 m (2 to 10.5 ft.)

**Flash Recycling Time:** Approx. 3 seconds (with new battery)

**Flash Conditions:** With flash mode button

- ① Full-auto mode: Automatically fires in low light conditions
- ② Auto mode with red-eye reduction: Automatically fires in low light conditions
- ③ Flash ON mode: Fires every time
- ④ Flash OFF mode: Does not fire
- ⑤ Slow-synchro mode: Fires every time (with red-eye reduction)

**Date/Title Function:**

Type: Built-in LCD panel and automatic calendar with quartz digital date/time clock, programmed with dates until the year 2040 (compensates automatically for long and short months and leap years)

Data types: Date/Date + Time, Titles (6 languages, 5 formats)

Character type: Depends on the lab's capabilities

Data color: Depends on the lab's capabilities

**Power Supply:** One lithium battery (CR2, 3V)

**Shooting Capacity:** Approx. 22 film cartridges of 25-exp. (at normal temperatures with 50% flash use)

**Dimensions (W × H × D):** 85 × 55 × 34.5 mm  
(3.4 × 2.2 × 1.4 in)

**Weight:** 115 g (4.1 oz.) (without battery)

- All data are based on Canon's Standard Test Method.
- Subject to change without notice

**F** Français



# MEMO

---

A series of horizontal dashed lines for writing.

# Canon

CANON INC. 30-2, Shimomaruko 3-chome, Ohta-ku, Tokyo 146-8501, Japan

U.S.A. ——— **CANON U.S.A. INC.**

For all inquiries concerning this camera, call toll free in the U.S.  
1-800-828-4040

or write to:

Customer Relations,  
Canon U.S.A., Inc.

One Canon Plaza, Lake Success, N.Y. 11042-1198

CANADA ——— **CANON CANADA INC. HEADQUARTERS**

6390 Dixie Road, Mississauga, Ontario L5T 1P7, Canada

**CANON CANADA INC. MONTREAL BRANCH**

5990, Côte-de-Liesse, Montréal Québec H4T 1V7, Canada

**CANON CANADA INC. CALGARY OFFICE**

2828, 16th Street, N.E. Calgary, Alberta T2E 7K7, Canada

For all inquiries concerning this camera, call toll free in Canada

1-800-828-4040

EUROPE, ——— **CANON EUROPA N.V.**

AFRICA &

MIDDLE EAST

Bovenkerkerweg 59-61, P.O. Box 2262, 1180 EG Amstelveen,  
The Netherlands

**CANON PHOTO VIDEO FRANCE S.A.**

11, Avenue Dubonnet Le Doublon 92407 Courbevoie Cedex, France

**CANON UK LTD.**

Brent Trading Centre, North Circular Road, London NW10 0JF, United  
Kingdom

**CANON EURO-PHOTO G. m. b. H.**

Siemensring 90-92, D-47877 Willich, Germany

**CANON ITALIA S.p.A.**

Palazzo L, Strada 6, 20089 Rozzano, Milanofiori, Milano, Italy

**CANON Benelux N.V./S.A.**

Besseneldstraat 7, 1831 Diegem (Machelen), Belgium

**CANON Schweiz AG**

Geschäftsbereich Wiederverkauf, Industriestrasse 12, CH-8305 Dietlikon,  
Switzerland

**CANON G. m. b. H.**

Oberlaaerstrasse 233, 4th floor, 1100 Wien, Austria

CENTRAL & ——— **CANON LATIN AMERICA, INC. DEPTO DE VENTAS**

SOUTH AMERICA

6505 Blue Lagoon Drive, Suite 325, Miami, FL33126 U.S.A.

**CANON LATIN AMERICA, INC. CENTRO DE SERVICIO Y REPARACION**

Apartado 2019, Zona Libre de Colón, República de Panamá

ASIA ——— **CANON SINGAPORE PTE. LTD.**

79 Anson Road #09-01/06 Singapore 079906

OCEANIA ——— **CANON AUSTRALIA PTY. LTD.**

1 Thomas Holt Drive, North Ryde, N.S.W. 2113, Australia

**CANON NEW ZEALAND LTD.**

Fred Thomas Drive, P.O. Box 33-336, Takapuna, Auckland, New Zealand

JAPAN ——— **CANON SALES CO., INC.**

12-15 Mita, 3-Chome, Minato-ku, Tokyo 108-8011, Japan